

UPDATE 2019

Aggiornamento Catalogo 14.A/ 14.A Catalog Supplement - GRUPPO/SECTION 5

PUNTE COMPONIBILE PER FORI CIECHI HW INTEGRALE Z=2 VHW DOWEL DRILLS Z=2

ART. L119

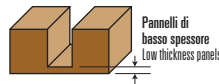
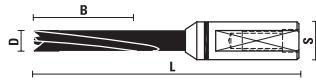

- Corpo in HW integrale
- Esecuzione con 2 eliche
- Affilatura con 2 incisori arrotondati e centrino piatto
- Per legno naturale, pressato, agglomerato, impiallacciato e laminato
- **Perfette per eseguire fori molto precisi su pannelli di basso spessore** grazie al centrino piatto e agli incisori laterali arrotondati
- **Solid carbide spiral portion**
- 2-flutes
- **Flat center-point and two rounded spurs**
- For natural wood, pressed wood, veneered, chipboard, laminated and MDF
- **Best quality holes when working with low thickness panels** thanks to the flat center-point and two rounded spurs

Rot. Dx/RH rot.	Rot. Sx/LH rot.	D	B	L	S
L119.050.R NEW	L119.050.L NEW	5	30	70	10x30
L119.080.R NEW	L119.080.L NEW	8	30	70	10x30



Z051.302.R

Su richiesta
On request



Z051.505.R

Aggiornamento Catalogo 14.A/ 14.A Catalog Supplement - GRUPPO/SECTION 7

PORTAUTENSILI CONO DIN 6499 (ER32) COLLET CHUCKS DIN 6499 (ER32)

ART. T118

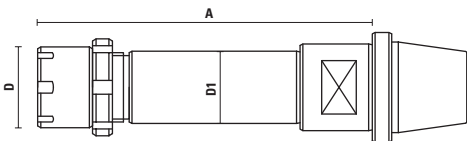

Viene fornito completo di ghiera ER20 Mini e controghiera (senza pinza)
Supplied with ER20 Mini nut and return ring nut (without spring collet)

Macchine/For. Bacci/Greda

Articolo/Item	A	D	D ₁	Pinze/Spring Collets	Ghiera/Clamping nut	Controghiera/Return ring nut	Rot.
T118.935.R NEW	85	28	25	∅ 2÷13 (Art. T126/ER20)	Z091.404.R (ER20 Mini)	Z091.904.R	Dx/Rh

PORTAUTENSILI CONO ISO 30

COLLET CHUCKS ISO 30

ART. T118

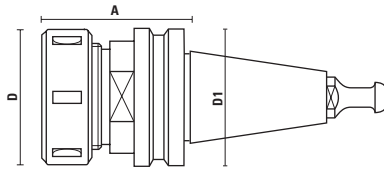

- Viene fornito completo di ghiera (senza pinza) e tirante
- La quota "A" è rilevata con l'utensile montato su pinza. Da notare che la quota "A" può subire variazioni in base al diametro dell'utensile in pinza.
- Da utilizzare con nostre pinze art. T133 con angolo di 3° (pag. 2)
- Con **speciale trattamento di micropallinatura**
- Supplied with nut (without collet) and retaining pawl
- The "A" measure will be determined with clamped tool shanks by using our spring collet
- The "A" measure may be subject to variations depending on the diameter of the clamped tools
- To be used with our spring collets with 3° taper angle only (see item T133 at page 2)
- **Special micro-shot peening treatment**

- Tirante/retaining pawl T118.891.R per macchine/for: **Biesse, Masterwood, Multiax**

Articolo/Item	Cono/Type	A	D	D1	Pinze/Spring collets	Ghiera/Clamping nut	Rot.
T118.841.R NEW	ISO 30	58	50	50	Ø 3÷25,4	Z091.005.R	Dx/Rh
Z052.305.N NEW	Chiave a settore 45/50/ Wrench 45/50						
Z052.735.N NEW	Chiave dinamometrica a settore/ Torque hook wrench - D= 50 - Nm 110/120 - Nm 190/200						

PORTAUTENSILI CONO HSK TIPO "F"

COLLET CHUCKS HSK TYPE "F"

ART. T118

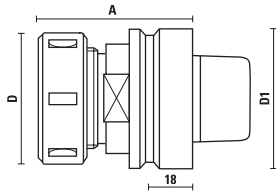

- Viene fornito completo di ghiera (senza pinza)
- La quota "A" è rilevata con l'utensile montato su pinza. Da notare che la quota "A" può subire variazioni in base al diametro dell'utensile in pinza
- Da utilizzare con nostre pinze art. T133 con angolo di 3° (pag. 2)
- Con **speciale trattamento di micropallinatura**
- Supplied with nut (without collet)
- The "A" measure will be determined with clamped tool shanks by using our spring collet
- The "A" measure may be subject to variations depending on the diameter of the clamped tools
- To be used with our spring collets with 3° taper angle only (see item T133 at page 2)
- **Special micro-shot peening treatment**

Per macchine/for: **Multiax**

Articolo/Item	Cono/Type	A	D	D1	Pinze/Spring collets	Ghiera/Clamping nut	Rot.
T118.941.R NEW	HSK 63F	58	50	63	Ø 3÷25,4	Z091.005.R	Dx/Rh
Z052.305.N NEW	Chiave a settore 45/50/ Wrench 45/50						
Z052.735.N NEW	Chiave dinamometrica a settore/ Torque hook wrench - D= 50 - Nm 110/120 - Nm 190/200						

PINZE 3° ALTA VELOCITÀ

SPRING COLLETS 3° TAPER ANGLE

ART. T133

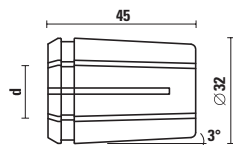

Da utilizzare solo sui coni T118.941.R e T118.841.R per pantografi CNC Multiax
To be used with our tool holders (see item T118.941.R and T118.841.R) for Multiax router machines only.

Precisione/Precision = 0,01

Articolo/Item	d	Articolo/Item	d
T133.032.N NEW	Ø 3,2 (1/8")	T133.120.N NEW	Ø 12 - 11,5
T133.040.N NEW	Ø 4 - 3,5	T133.127.N NEW	Ø 12,7 (1/2")
T133.060.N NEW	Ø 6 - 5,5	T133.159.N NEW	Ø 15,9 (5/8")
T133.064.N NEW	Ø 6,4 (1/4")	T133.160.N NEW	Ø 16 - 15,5
T133.079.N NEW	Ø 7,9 (5/16")	T133.191.N NEW	Ø 19,1 (3/4")
T133.080.N NEW	Ø 8 - 7,5	T133.200.N NEW	Ø 20 - 19,5
T133.095.N NEW	Ø 9,5 (3/8")	T133.250.N NEW	Ø 25 - 24,5
T133.100.N NEW	Ø 10 - 9,5	T133.254.N NEW	Ø 25,4 (1")

ADATTATORE PER SEGHE CIRCOLARI ADAPTERS FOR CIRCULAR SAWBLADES

ART. T128

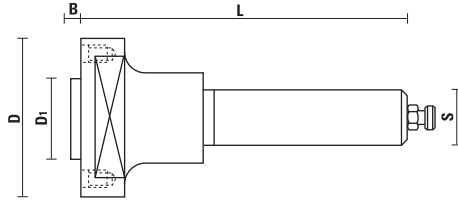

- Nr. 4 fori M6/90° interasse 48 mm
- Viene fornito completo di nr. 4 viti per il fissaggio della lama e vite di sicurezza
- Da utilizzare con seghe circolari foro \varnothing 30
- Si consiglia l'utilizzo con seghe circolari di diametro compreso tra 150 e 200 mm.
- Nr. 4 pin holes with M6/90° and 48 mm pitch circle diameter
- Complete with nr. 4 screws to fix the sawblade
- For mounting sawblades with 30 mm bore
- Recommended to use sawblades with diameters between 150 and 200 mm

Articolo/Item	D	D1	B	S	L
T128.143.R NEW	60	30	2,5	\varnothing 16x50	85



Z051.014.R



Z051.506.R

ADATTATORE HSK63E PER SEGHE CIRCOLARI HSK63E ADAPTERS FOR CIRCULAR SAWBLADES

ART. T128

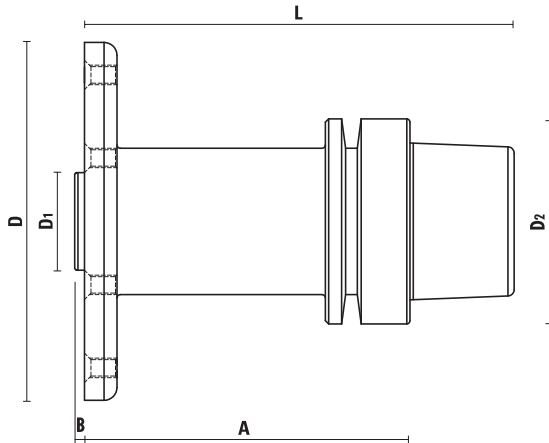
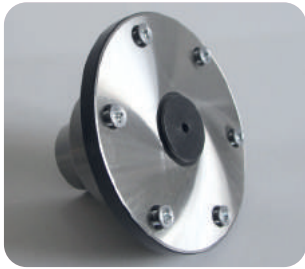

- Viene fornito di nr. 6 viti M6x10 per il corretto serraggio della lama con interasse 90 mm a 60°
- Da utilizzare con seghe circolari foro \varnothing 30
- Si consiglia l'utilizzo con seghe circolari di diametro compreso tra 200 e 350 mm.

- Complete with nr. 6 screws (M6x10) for the proper assembly of sawblades with 60° at 90 mm distance
- For mounting sawblades with 30 mm bore
- For mounting sawblades with diameter between 200 and 350 mm.

Articolo/Item	A	D	D1	D2	B	L
T128.170.R NEW	40	110	30	63	2,5	72
T128.175.R NEW	100	110	30	63	2,5	132



Z051.014.R

ESEMPIO DI MONTAGGIO/EXAMPLE OF USE:

Adattatore HSK63 con lama inserita
HSK63 adapter with mounted Saw Blade

OPTIONAL/ OPTIONS:
Flangia di sicurezza (art. Z092.100.N) per montare lame fino a 400 mm di diametro cambiando le viti.
Security flange (item Z092.100.N) to secure sawblades with maximum diameter of 400 mm by changing screws.

VITE/SCREW (ART. Z051.014.R)

Vite M6x10 con testa svasata per il serraggio della lama
M6x10 countersunk flat head screw

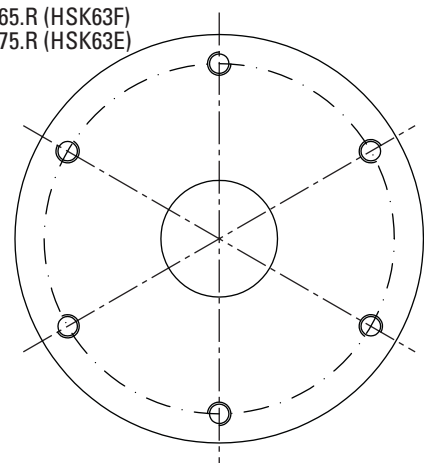
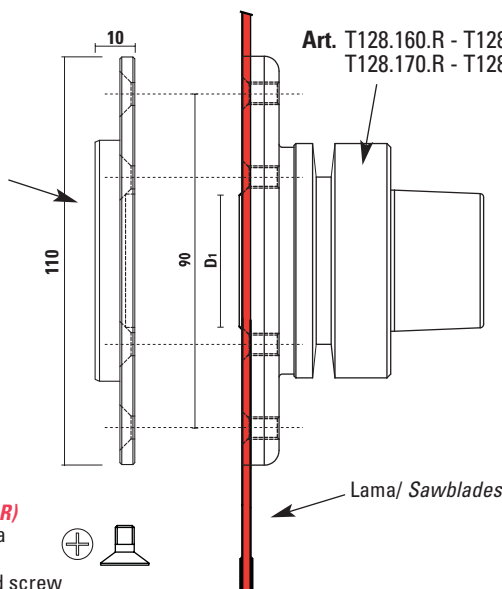

FRESE HW INTEGRALE ELICA DESTRA Z=2 SOLID CARBIDE SPIRAL CUTTERS, FINISH STYLE Z=2

ART. T142

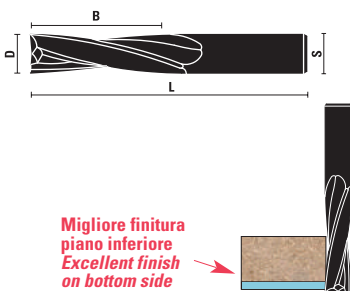

- Rotazione destra con elica destra "TIPO TRAENTE"
- Per centri di lavoro, pantografi CNC e macchine punto a punto
- **Right-hand rotation with "UP CUT SPIRAL"**
- To be used on machining centres, CNC routers and point to point machines

Rotaz. Dx/RH rotation	D	B	L	S
T142.032.R NEW	1/8"	1/2"	2"	1/8"
T142.048.R NEW	3/16"	3/4"	2"	3/16"
T142.064.R NEW	1/4"	3/4"	2"	1/4"
T142.065.R NEW	1/4"	1-1/4"	2-1/2"	1/4"
T142.079.R NEW	5/16"	1"	2-1/2"	5/16"
T142.095.R NEW	3/8"	1-1/4"	3"	3/8"
T142.127.R NEW	1/2"	1-1/4"	3"	1/2"
T142.128.R NEW	1/2"	2"	4"	1/2"

Per frese da \varnothing 12 a \varnothing 20 si esegue sede per anello di ritaglio (Seeger)
Router bits with diameter from 12 mm to 20 mm, are produced with shank for Seeger retaining rings



FRESE S=1/4" HW INTEGRALE ELICA DESTRA Z=2 SOLID CARBIDE SPIRAL CUTTERS, FINISH STYLE Z=2

ART. T164

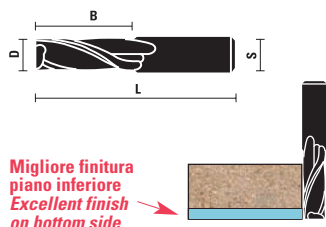

- Utilizzabile anche su pantografi portatili
- Rotazione destra con elica destra "TIPO TRAENTE"
- Can also be used on portable routers
- **Right-hand rotation with "UP CUT SPIRAL"**

Rotaz. Dx/RH rotation	D	B	L	S
T164.032.R NEW	1/8"	1/2"	2"	1/4"
T164.048.R NEW	3/16"	3/4"	2"	1/4"

FRESE HW INTEGRALE ELICA SINISTRA Z=2 SOLID CARBIDE SPIRAL CUTTERS, FINISH STYLE Z=2

ART. T152

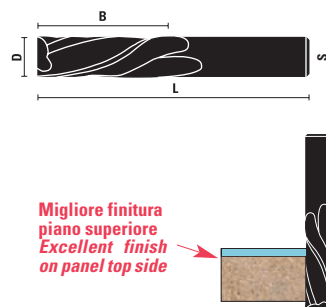

- Rotazione destra con elica sinistra "TIPO SPINGENTE"
- Per centri di lavoro, pantografi CNC e macchine punto a punto
- **Right-hand rotation with "DOWN CUT SPIRAL"**
- To be used on machining centres, CNC routers and point to point machines

Rotaz. Dx/RH rotation	D	B	L	S
T152.032.R NEW	1/8"	1/2"	2"	1/8"
T152.048.R NEW	3/16"	3/4"	2"	3/16"
T152.064.R NEW	1/4"	3/4"	2"	1/4"
T152.065.R NEW	1/4"	1-1/4"	2-1/2"	1/4"
T152.079.R NEW	5/16"	1"	2-1/2"	5/16"
T152.095.R NEW	3/8"	1-1/4"	3"	3/8"
T152.127.R NEW	1/2"	1-1/4"	3"	1/2"
T152.128.R NEW	1/2"	2"	4"	1/2"

Per frese da \varnothing 12 a \varnothing 20 si esegue sede per anello di ritaglio (Seeger)
Router bits with diameter from 12 mm to 20 mm, are produced with shank for Seeger retaining rings



FRESE HW INTEGRALE CONICA Z=3 SOLID CARBIDE TAPERED BALL NOSE SPIRAL BITS Z=3

ART. T173



- Rotazione destra con elica destra "TIPO TRAENTE"
- Appositamente pensate per la fresatura e l'intaglio 2D e 3D su plastica, alluminio e legno
- Per centri di lavoro e pantografi C.N.C.
- **Right-hand rotation with "UP CUT SPIRAL"**
- Specially designed for smooth 2D and 3D carving in plastic, aluminium and wood
- Use on CNC and high speed machines

Rotaz. Dx/RH rotation	D	B	L	R	S
T173.008.R NEW	1/32"	1"	3"	1/64"	1/4"
T173.009.R NEW	0,8	25	70	0,4	6
T173.016.R NEW	1/16"	1"	3"	1/32"	1/4"
T173.017.R NEW	1,6	25	70	0,8	6
T173.018.R NEW	1,6	30	80	0,8	8
T173.031.R NEW	1/8"	1"	3"	1/16"	1/4"
T173.032.R NEW	1/8"	2-1/2"	4"	1/16"	1/2"
T173.033.R NEW	3,17	30	70	1,59	6
T173.034.R NEW	3,17	50	90	1,59	8
T173.064.R NEW	1/4"	2"	4"	1/8"	1/2"

FRESE HW INTEGRALE ELICA DESTRA Z=3 SOLID CARBIDE SPIRAL CUTTERS, ROUGHING STYLE Z=3

ART. T144

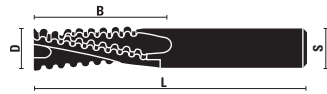

- Rotazione destra con elica destra "TIPO TRAENTE"
- Esecuzione con rompitruciolo
- Per centri di lavoro, pantografi CNC e macchine punto a punto
- Adatte alla sgrossatura, garantiscono una elevata velocità di avanzamento
- **Right-hand rotation with "UP-CUT STYLE"**
- **Chip-breaker execution**
- To be used on machining centres, CNC routers and point to point machines
- Suitable for roughing, they guarantee a high feed rate

Rotaz. Dx/RH rotation	D	B	L	S
T144.095.R NEW	3/8"	1"	3"	3/8"
T144.127.R NEW	1/2"	1-1/8"	3"	1/2"
T144.128.R NEW	1/2"	1-5/8"	3-1/2"	1/2"
T144.159.R NEW	5/8"	2"	4"	5/8"
T144.191.R NEW	3/4"	2"	4"	3/4"

FRESE HW INTEGRALE A DOPPIA ELICA Z=2+2 SOLID CARBIDE MORTISE COMPRESSION Z=2+2

ART. T156.M

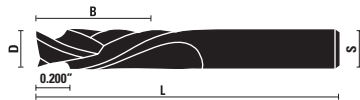

Migliore finitura
su entrambi i piani
Excellent finish on both
upper and lower side

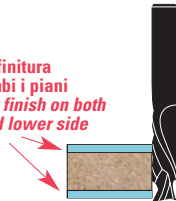

- Rotazione destra con doppia elica a compressione
- Ottima finitura del pannello su entrambi i piani
- Queste frese sono caratterizzate da una minore lunghezza della parte traente per mortasare
- Per legni teneri e duri, pannelli truciolati, MDF, HF, laminati su due lati, lamellari, termoplastici, materiali minerali (CORIAN® ecc.)
- Per centri di lavoro, pantografi CNC e macchine punto a punto
- **Right-hand rotation with double flute, mortise compression spiral**
- **Excellent finish on both upper and lower side of the panel**
- These tools have a shorter up-cut section compared to standard compression bits. They are suitable for mortising, grooving, routing and dado
- For softwood and hardwood, chipboard, MDF, HF, double-sided melamine and laminated, plywood, plastic coated, mineral materials (CORIAN® ecc.)
- To be used on machining centres, CNC routers and point to point machines

Rotaz. Dx/RH rotation	D	B	L	S
T156.095.RM NEW	3/8"	7/8"	3"	3/8"
T156.096.RM NEW	3/8"	1-1/4"	3"	3/8"
T156.127.RM NEW	1/2"	7/8"	3"	1/2"
T156.128.RM NEW	1/2"	1-1/4"	3"	1/2"
T156.129.RM NEW	1/2"	1-5/8"	3-1/2"	1/2"

FRESE HW INTEGRALE ELICA SINISTRA Z=3 SOLID CARBIDE SPIRAL CUTTERS, ROUGHING STYLE Z=3

ART. T154

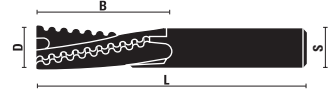

- Rotazione destra con elica sinistra "TIPO SPINGENTE"
- Esecuzione con rompitruciolo
- Per centri di lavoro, pantografi CNC e macchine punto a punto
- Adatte alla sgrossatura, garantiscono una elevata velocità di avanzamento
- **Right-hand rotation with "DOWN-CUT STYLE"**
- **Chip-breaker execution**
- To be used on machining centres, CNC routers and point to point machines
- Suitable for roughing, they guarantee a high feed rate

Rotaz. Dx/RH rotation	D	B	L	S
T154.095.R NEW	3/8"	1"	3"	3/8"
T154.127.R NEW	1/2"	1-1/8"	3"	1/2"
T154.128.R NEW	1/2"	1-5/8"	3-1/2"	1/2"
T154.159.R NEW	5/8"	2"	4"	5/8"
T154.191.R NEW	3/4"	2"	4"	3/4"

FRESE HW INTEGRALE A COMPRESSIONE Z=3+3 SOLID CARBIDE MORTISE COMPRESSION Z=3+3

ART. T356.M

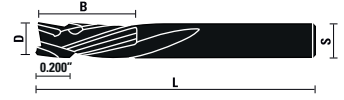

Migliore finitura
su entrambi i piani

Excellent finish on both
upper and lower side

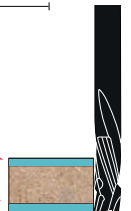

- Rotazione destra
- Ottima finitura del pannello su entrambi i piani
- Queste frese sono caratterizzate da una minore lunghezza della parte traente per mortasare
- Per legni teneri e duri, pannelli truciolati, MDF, HF, laminati su due lati, lamellari, termoplastici, materiali minerali (CORIAN® ecc.)
- Per centri di lavoro, pantografi CNC e macchine punto a punto
- **Right-hand rotation**
- **Excellent finish on both upper and lower side of the panel**
- These tools have a shorter up-cut section compared to standard compression bits. They are suitable for mortising, grooving, routing and dado
- For softwood and hardwood, chipboard, MDF, HF, double-sided melamine and laminated, plywood, plastic coated, mineral materials (CORIAN® ecc.)
- To be used on machining centres, CNC routers and point to point machines

Rotaz. Dx/RH rotation	D	B	L	S
T356.095.RM NEW	3/8"	7/8"	3"	3/8"
T356.096.RM NEW	3/8"	1-1/4"	3"	3/8"
T356.127.RM NEW	1/2"	7/8"	3"	1/2"
T356.128.RM NEW	1/2"	1-1/4"	3"	1/2"

FRESE HW INTEGRALE ELICA DESTRA Z=1-Z=2 SOLID CARBIDE SPIRAL BITS UP CUT Z=1 - Z=2

ART. U111 - U112

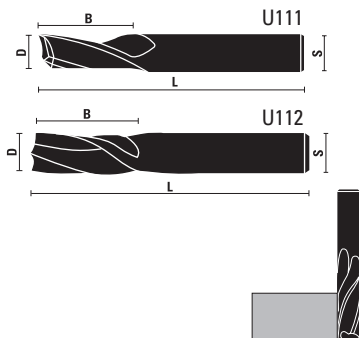

- Rotazione destra con elica destra "TIPO TRAENTE"
- Tagliente lappato per un minore attrito e una migliore fuoriuscita del truciolo
- Per centri di lavoro e pantografi C.N.C.
- Per: • alluminio • plastica • fibra di vetro
• fenoli • acrilici • PVC
- Right-hand rotation with "UP CUT SPIRAL"
- Polished cutting edge for improved chip evacuation. Mirror finish
- Spiral 'O' flute sharpening
- Use on CNC and high speed machines
- For working: • aluminium • fiberglass • plastic
• phenolic • acrylic • PVC

Rotaz. Dx/RH rotation	D	B	L	S	Z
U111.032.R NEW	1/8"	1/2"	2"	1/4"	1
U111.048.R NEW	3/16"	5/8"	2"	1/4"	1
U111.064.R NEW	1/4"	3/4"	2"	1/4"	1
U111.095.R NEW	3/8"	3/4"	3"	3/8"	1
U111.127.R NEW	1/2"	1-1/4"	3"	1/2"	1
U112.048.R NEW	3/16"	1/2"	2"	1/4"	2
U112.064.R NEW	1/4"	3/4"	2"	1/4"	2
U112.095.R NEW	3/8"	1"	3"	3/8"	2
U112.127.R NEW	1/2"	1-1/2"	3-1/2"	1/2"	2

Per frese da Ø 12 a Ø 16 si esegue sede per anello di ritegno (Seeger)
Router bits with diameter from 12 mm to 16 mm, are produced with shank fit for Seeger retaining rings



FRESE HW INTEGRALE ELICA DESTRA Z=1-Z=2 SOLID CARBIDE SPIRAL BITS UP CUT Z=1 - Z=2

ART. U111.KD - U112.KD

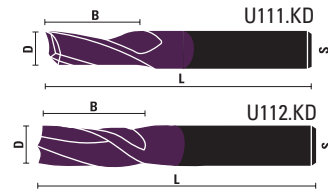

Ricoperte KleinDIA per grandi prestazioni

KleinDIA coating for excellent performance

- Rotazione destra con elica destra "TIPO TRAENTE"
- Tagliente lappato e ricoperto per un minore attrito e una migliore fuoriuscita del truciolo
- Per centri di lavoro e pantografi C.N.C.
- Per: • alluminio • plastica • fibra di vetro
• fenoli • acrilici • PVC
- Right-hand rotation with "UP CUT SPIRAL"
- Polished and coated cutting edge for improved chip evacuation. Mirror finish
- Spiral 'O' flute sharpening
- Use on CNC and high speed machines
- For working: • aluminium • fiberglass • plastic
• phenolic • acrylic • PVC

Rotaz. Dx/RH rotation	D	B	L	S	Z
U111.032.RKD NEW	1/8"	1/2"	2"	1/4"	1
U111.048.RKD NEW	3/16"	5/8"	2"	1/4"	1
U111.064.RKD NEW	1/4"	3/4"	2"	1/4"	1
U111.095.RKD NEW	3/8"	3/4"	3"	3/8"	1
U111.127.RKD NEW	1/2"	1-1/4"	3"	1/2"	1
U112.048.RKD NEW	3/16"	1/2"	2"	1/4"	2
U112.064.RKD NEW	1/4"	3/4"	2"	1/4"	2
U112.095.RKD NEW	3/8"	1"	3"	3/8"	2
U112.127.RKD NEW	1/2"	1-1/2"	3-1/2"	1/2"	2

Per frese da Ø 12 a Ø 16 si esegue sede per anello di ritegno (Seeger)
Router bits with diameter from 12 mm to 16 mm, are produced with shank fit for Seeger retaining rings



FRESE IN HW INTEGRALE PER VETRORESINA, RICOPERTE KleinDIA SOLID CARBIDE BITS FOR FIBERGLASS WORKING KleinDIA COATED

ART. U130.KD



Ricoperte KleinDIA per grandi prestazioni

KleinDIA coating for excellent performance

- Per lavorazione di materie plastiche, gomma dura e fibra di vetro
- Rotazione destra
- Per contornare e rasare frontale
- Da utilizzare su fresatrici, pantografi CNC e macchine portatili
- For working plastic materials, rubber and fiberglass
- Right-hand rotation
- For routing and shearing
- To be used on portable machines, CNC and routing machines

Rotaz. Dx/RH rotation	D	B	L	S
U130.064.RKD NEW	1/4"	1"	3"	1/4"
U130.095.RKD NEW	3/8"	1-1/4"	3-1/4"	3/8"
U130.127.RKD NEW	1/2"	1-1/2"	3-1/2"	1/2"

TRIMATIC 22,4 FORATURA PER "LAMELLO CABINEO" TRIMATIC 22,4 FOR "LAMELLO CABINEO"

trimatic®



L'unica attrezzatura presente sul mercato che consente con un normale trapano a colonna o un trapano elettrico portatile di eseguire la foratura per l'inserimento della giunzione "Lamello Cabineo" in modo facile e veloce. Si rivolge a tutti gli artigiani, hobbisti e fai da te che non sono in possesso di una macchina CNC.

The new and only drilling jig which allows you to make three blind holes in a single pass for inserting the new furniture connector "Lamello Cabineo" by using a portable power drill or pillar drill. It is specially made for hobbyists, artisans and craftsmen who do not own CNC router machines.

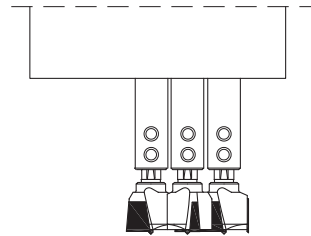
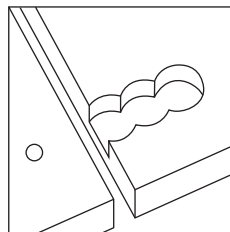
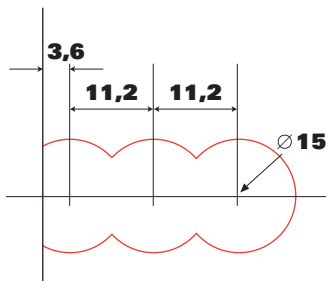

Sx/Lh Dx/Rh Sx/Lh

Articolo/Item

TRIMATIC 22,4 **NEW**

Attenzione la punta centrale ha rotazione destra e le punte laterali hanno rotazione sinistra.
The central bit must have right hand rotation, the lateral bits have left hand rotation

Punte in HW per attrezzature TRIMATIC 22,4 per la foratura "Lamello Cabineo" (non incluse)
HW tools suitable for TRIMATIC 22,4, for "Lamello Cabineo" (not included)

S Ø 6	Descrizione/Description	Rotazione/Rotation
L174.150.R NEW	Ø 15x35	Dx/Rh
L174.150.L NEW	Ø 15x35	Sx/Lh



L174.150.R



L174.150.L

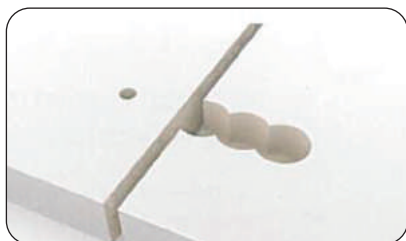

DESCRIZIONE/DESCRIPTION

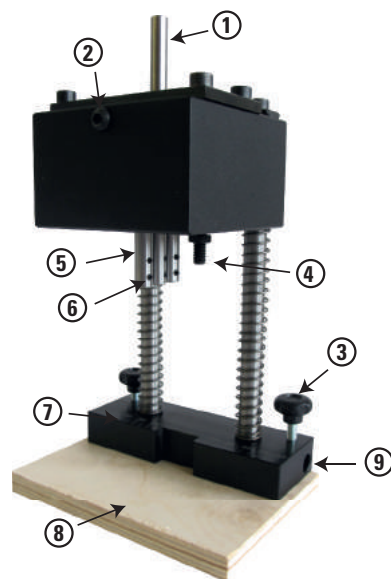

- 1) Attacco per mandrino trapano
- 2) Foro filettato per ingrassaggio
- 3) Pomello di bloccaggio asta di battuta laterale
- 4) Vite di regolazione profondità dei fori
- 5) Boccole porta utensili
- 6) Viti di bloccaggio utensili
- 7) Base con scala millimetrata
- 8) Tavoletta sostegno attrezzatura
- 9) Foro di scorrimento asta battuta laterale

- 1) Arbor for pillar drill spindle
- 2) Threaded hole for greasing
- 3) Locking knob for stop reference rod
- 4) Threaded screw for depth adjustment
- 5) Tool holder bush
- 6) Tool locking screw
- 7) Basement with millimetric scale
- 8) Equipment support table
- 9) Stop rod sliding hole

DIMENSIONI/DIMENSIONS

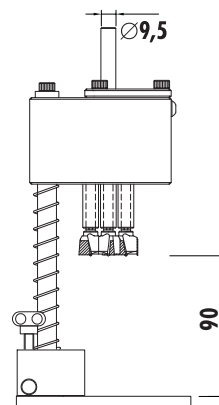

La speciale scala millimetrata alla base del trimatic vi faciliterà nella foratura del foro cieco Ø5 mm nel pannello corrispondente per stringere la vite della giunzione Cabineo®.

The special millimetric scale on the basement will help you to make the Ø5 mm hole in the corresponding workpiece to tighten the screw of Cabineo® with accuracy

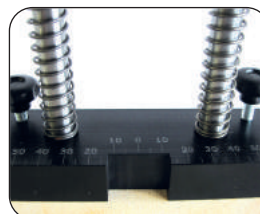

Cabineo® è un prodotto
Cabineo® is a product of



PRE SET PERFORMANCE

Progettati e sviluppati dalla ditta m.conti e SISTEMI nel campo della costruzione degli utensili, i Preset PERFORMANCE sono indispensabili anche nei centri affilatura o nei laboratori di produzione mobili o serramenti, per il controllo dello stato degli utensili e per il loro settaggio prima di essere montati in macchina. Completo dei software GHOST, DXF e Interlock System per il fissaggio meccanico degli utensili.

Designed and developed by m.conti and SISTEMI in the field of tooling manufacture, the Preset PERFORMANCE are also essential in sharpening centers and production units of furniture or windows, for checking the condition of the tools and their settings before being mounted in the machine. Fully equipped with DXF and GHOST Softwares and Interlock System to mechanically locked all the tools.



PERFORMANCE 44

H 400 - Ø400

PERFORMANCE 45

H 500 - Ø400

PERFORMANCE 46

H 600 - Ø400

PERFORMANCE 65

H 500 - Ø600

PERFORMANCE 66

H 600 - Ø600

PERFORMANCE 68

H 800 - Ø600

Optional/Options

PRE-SET BL.HS.HSK63

Bussola a bloccaggio pneumatico
Cone holder for mechanical locking **NEW**

PRESET 105

Schermo touch 22"
(da richiedere al momento dell'ordine e da sostituire con quello standard presente)
22" touch screen
(To be included at the time of order and replace the standard)

PRE SET LEADER PLUS

Presetter dalle elevate prestazioni, potente e facilissimo da usare. Diventa strumento di controllo utensili sofisticato grazie a moduli software dedicati quali GHOST e DXF. Sistema di bloccaggio meccanico INTERLOCK SYSTEM (optional)*.

High performance presetter, powerful and very easy to use. Also a sophisticated instrument for tool analysis thanks to dedicated modules such as GHOST and DXF. Precise measures by mechanical locking tools with INTERLOCK SYSTEM (option).*



LEADER PLUS 44

H 400 - Ø400

LEADER PLUS 45

H 500 - Ø400

Optional/Options

PRESET 099

Banchetto di supporto
Holding cart

PRESET 100

Software DXF
DXF Software

PRESET 103

Stampante etichette Dymo 450
Label printer Dymo 450

PRESET 105

Schermo touch 22"
(da richiedere al momento dell'ordine e da sostituire con quello standard presente)
22" touch screen
(To be included at the time of order and replace the standard)

* PRESET 101

Interlock System (no ISO 30)
Interlock System (no ISO 30)

* PRESET 102

Tiranti per Interlock System
Interlock retaining pawls

* PRE-SET BL.HS.HSK63

Bussola a bloccaggio pneumatico
Cone holder for mechanical locking **NEW**

PRE SET UNIKO

Presetter completo, robusto e semplicissimo da usare. Dotato di tutto il necessario per entrare nel mondo presetting con telecamera. Verifica della geometria utensile facile ed intuitiva. Potente Post Processor per integrarsi in ogni ambiente produttivo.

Fully equipped, sturdy and extremely easy to use. Entering the world of camera presetting is easy with this user friendly presetter. Checking tool geometry is easy and intuitive. Powerful Post Processor to easily integrate in any working condition.



UNIKO 44

H 400 - Ø400

UNIKO 45

H 500 - Ø400

Optional/Options

PRESET 099

Banchetto di supporto
Holding cart

PRESET 104

Anello LED a luce fredda
LED ring cold light

PRESET 103

Stampante etichette Dymo 450
Label printer Dymo 450

BUSSOLE DI RICAMBIO/ SPARE CONE-HOLDERS



Articolo/Item	Descrizione/Description
PRE-SET BL.ISO 30	per coni ISO 30 for tool holders ISO 30
PRE-SET BL.ISO 40	per coni ISO 40 for tool holders ISO 40
PRE-SET BL.ISO 50	per coni ISO 50 for tool holders ISO 50
PRE-SET BL.HSK 63F	per coni HSK 63F/D/B for tool holders HSK 63F/D/B
PRE-SET BL.HSK 63A	per coni HSK 63A/C/E for tool holders HSK 63A/C/E
PRE-SET BL.HSK 80A	per coni HSK 80 for tool holders HSK 80
PRE-SET BL.30x130	con albero L=130, per frese d= 30 with arbor L=130, for tools with bore d= 30
PRE-SET BL.30x300	con albero L=300, per frese d= 30 with arbor L=300, for tools with bore d= 30
PRE-SET BL.35x130	con albero L=130, per frese d= 35 with arbor L=130, for tools with bore d= 35
PRE-SET BL.35x300	con albero L=300, per frese d= 35 with arbor L=300, for tools with bore d= 35
PRE-SET BL.40x130	con albero L=130, per frese d= 40 with arbor L=130, for tools with bore d= 40
PRE-SET BL.40x300	con albero L=300, per frese d= 40 with arbor L=300, for tools with bore d= 40
PRE-SET BL.50x130	con albero L=130, per frese d= 50 with arbor L=130, for tools with bore d= 50
PRE-SET BL.50x300	con albero L=300, per frese d= 50 with arbor L=300, for tools with bore d= 50
PRE-SET BL.HS.HSK63	Bussola a bloccaggio pneumatico Cone holder for mechanical locking NEW